



## TRANS-AUTO AUTOMATIC START UNIT

### 1. Introduction

#### 1.1 General Specifications

The unit provides automatic start and stop the engine and protect the generator system. Both automatic and manual control is possible. A test mode is also available which allows the generator to be run for checking the generator system.

The unit has Dual Working feature. In the event of a remote start, group with high priority starts and takes the load. If both groups has no priority, the group with less working hour will start and take the load. To use Dual Working feature Dual Set expansion module must be used.

The unit calculates engine RPM from Magnetic Pickup sensor (MPU) and/or generator voltage signal.

The unit monitors J1939 ECU messages and provides remote start/stop control via J1939 protocol (supported ECUs: Volvo EMS2, Volvo EDC4, Perkins, Scania S6, MAN MFR and standard messages).

The unit monitors generator operation and gives warning of any faults that are detected.

The unit has Remote Start input for remote control of the engine.

The configurable input-3 can be used as the water level sensing input.

The configurable input-7 can be used as the cabin temperature analog input.

#### 1.2 Warranty

EMKO Elektronik warrants that the equipment delivered is free from defects in material and workmanship. This warranty is provided for a period of two years. The warranty period starts from the delivery date. This warranty is in force if duty and responsibilities which are determined in warranty document and instruction manual performs by the customer completely.

#### 1.3 Maintenance

Repairs should only be performed by trained and specialized personnel. Cut power to the device before accessing internal parts.

Do not clean the case with hydrocarbon-based solvents (Petrol, Trichlorethylene etc.). Use of these solvents can reduce the mechanical reliability of the device. Use a cloth dampened in ethyl alcohol or water to clean the external plastic case.

## 2. Installation



**Before beginning installation of this product, please read the instruction manual and warnings below carefully.**

A visual inspection of this product for possible damage occurred during shipment is recommended before installation. It is your responsibility to ensure that qualified mechanical and electrical technicians install this product.

If there is danger of serious accident resulting from a failure or defect in this unit, power off the system and separate the electrical connection of the device from the system.

Keep the power off until all of the wiring is completed so that electric shock and trouble with the unit can be prevented.

### 2.1 Unit Configuration

The unit can be programmed using the buttons and LCD display on the front panel or PC Software.

### 2.2 Panel Mounting

The unit is designed for panel mounting. Fixing is by two screw fixings.

**1-** Insert the unit in the panel cut-out from the front.

**2-** Insert the fixings in the slotted at the corners of the unit and tighten the fixing screws to secure the unit against the panel.



**During the equipment is putted in hole on the metal panel while mechanical installation some metal burrs can cause injury on hands, you must be careful.**

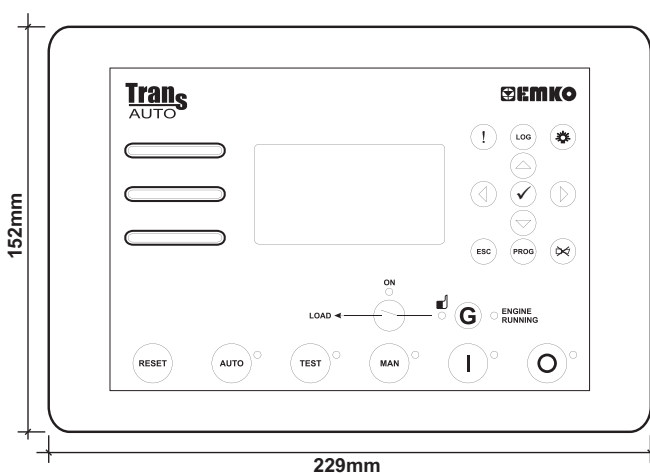

Figure 2.1 Front View

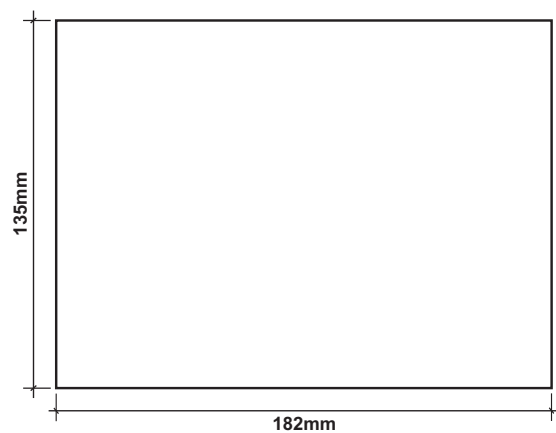
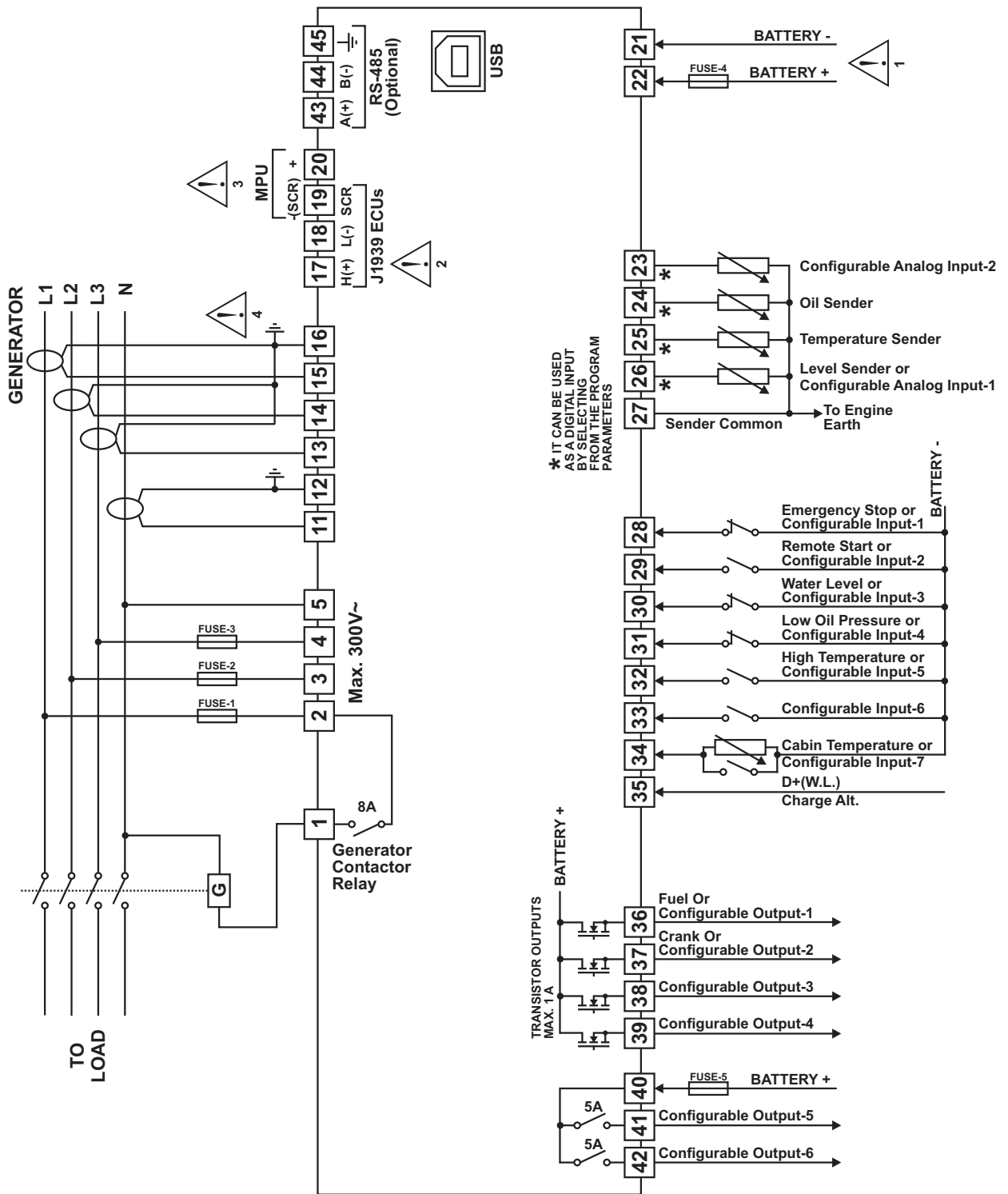

Figure 2.2 Panel Cut-Out

## 2.3 Electrical Connection

TRANS-AUTO three phase connections schematic



FUSE-1 8A. T  
 FUSE-4 6A. T  
 FUSE-5 Max. 10A. T

FUSE-2, FUSE-3 2A. T



- 1- Connect the unit as shown in the appropriate diagram. Be sure to connect the battery supply the right way round and battery negative should be grounded.
- 2- The CAN interface requires that a 120 Ohms terminator is fitted to each end of the communications link. This termination resistor is fitted internally into the unit. So it is not required externally. The screen is grounded at one end ONLY.
- 3- Screened cable must be used for connecting the Magnetic Pickup, ensuring that the screen is grounded at one end ONLY.
- 4- Current transformers secondary should be grounded.

### 3. Changing And Saving Parameters Values

#### Operation Screen

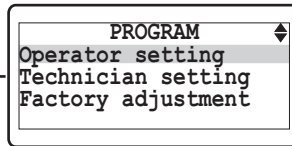
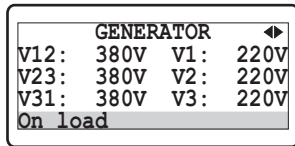

Press the Up or Down buttons to select the section you wish to view/change.

When the Prog button is pressed, the parameters section is asked for accessing to parameters.

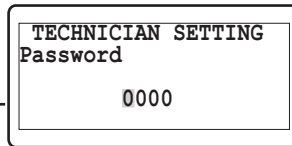
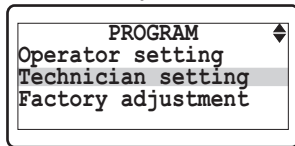

Enter password with cursor (Right, Left, Up and Down) buttons.

Press the Enter button.

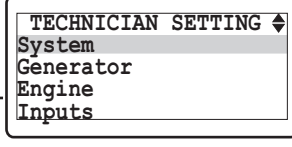
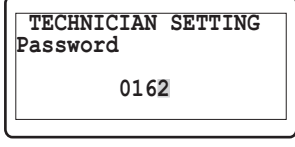

Press the Up or Down buttons to select the main parameter group you wish to view/change.

**Note1:** If Enter button is pressed and the technician password is zero, Password screen is ignored.

Press the Enter button to confirm password. If the password is incorrect, the unit will drop out of program mode.

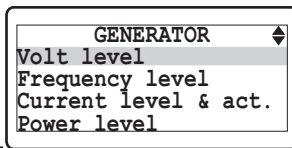
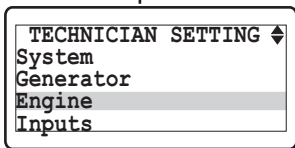

Press Enter button to access to all parameters page in currently main parameter group.

Press Enter button to access to all parameters in currently parameter page.

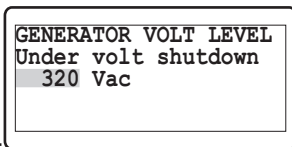
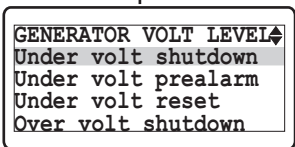

Parameter can be changed with Up and Down buttons.

Press the Enter button to view parameter value.

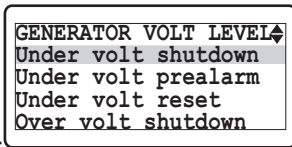
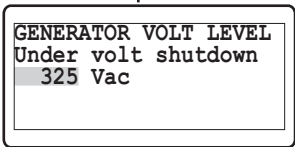

Press Enter button to confirm the changed value.

To exit from programming mode any time, press Prog button.

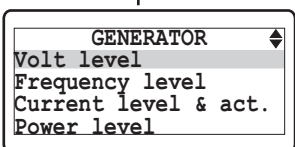

When the Escape button is pressed any time, previous page can be accessed.

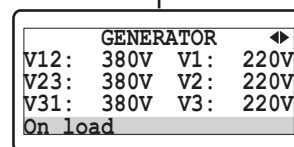

#### Operation Screen

## 4. Parameters

### 4.1 Operator Parameters

#### 4.1.1 Generator

<b>GENERATOR VOLT LEVEL (<i>Generator-&gt;Volt level</i>)</b>		<b>Min</b>	<b>Max</b>	<b>Default</b>	<b>Unit</b>
<b>Under volt shutdown</b>	Generator Under Voltage Shutdown	60(dis)	600	320	V~
<b>Under volt prealarm</b>	Generator Under Voltage Pre-Alarm	60(dis)	600	340	V~
<b>Under volt reset</b>	Generator Under Voltage Pre-Alarm Reset	60	600	350	V~
<b>Over volt shutdown</b>	Generator Over Voltage Shutdown	60	600	440	V~
<b>Over volt prealarm</b>	Generator Over Voltage Pre-Alarm	60(dis)	600	420	V~
<b>Over volt reset</b>	Generator Over Voltage Pre-Alarm Reset	60	600	400	V~
<b>Shutdown delay time</b>	Generator Voltage Shutdown Delay Time	0.0	10.0	1.0	Sec

<b>GENERATOR FREQ LEVEL (<i>Generator-&gt;Frequency level</i>)</b>		<b>Min</b>	<b>Max</b>	<b>Default</b>	<b>Unit</b>
<b>Nominal frequency</b>	Nominal Alternator Frequency	30.0	75.0	50.0	Hz
<b>Under freq shutdown</b>	Generator Under Frequency Shutdown	30.0(dis)	75.0	43.0	Hz
<b>Under freq prealarm</b>	Generator Under Frequency Pre-Alarm	30.0(dis)	75.0	45.0	Hz
<b>Under freq reset</b>	Generator Under Frequency Pre-Alarm Reset	30.0	75.0	46.0	Hz
<b>Over freq shutdown</b>	Generator Over Frequency Shutdown	30.0(dis)	75.0	58.0	Hz
<b>Over freq prealarm</b>	Generator Over Frequency Pre-Alarm	30.0(dis)	75.0	55.0	Hz
<b>Over freq reset</b>	Generator Over Frequency Pre-Alarm Reset	30.0	75.0	54.0	Hz
<b>Shutdown delay time</b>	Generator Frequency Shutdown Delay Time	0.0	10.0	1.0	Sec

<b>GENERATOR CUR LEVEL (<i>Generator-&gt;Current level</i>)</b>		<b>Min</b>	<b>Max</b>	<b>Default</b>	<b>Unit</b>
<b>Under cur. set</b>	Generator Under Current Set	0	9999	1	A~
<b>Under cur. prealarm</b>	Generator Under Current Pre-Alarm	0(dis)	9999	dis	A~
<b>Under cur. reset</b>	Generator Under Current Pre-Alarm Reset	0	9999	5	A~
<b>Over cur. IDMT alarm</b>	Generator Over Current IDMT Alarm	ENABL/DISBL		DISBL	
<b>Over cur. set</b>	Generator Over Current Set	0	9999	9999	A~
<b>Over cur. prealarm</b>	Generator Over Current Pre-Alarm	0(dis)	9999	9990	A~
<b>Over cur. reset</b>	Generator Over Current Pre-Alarm Reset	0	9999	9980	A~

<b>GEN POWER LEVEL (<i>Generator-&gt;Power level</i>)</b>		<b>Min</b>	<b>Max</b>	<b>Default</b>	<b>Unit</b>
<b>Under power set</b>	Generator Under Power Set	0	9999	0	kVA
<b>Under power prealarm</b>	Generator Under Power Pre-Alarm	0(dis)	9999	dis	kVA
<b>Under power reset</b>	Generator Under Power Pre-Alarm Reset	0	9999	5	kVA
<b>Over power IDMT alarm</b>	Generator Over Power IDMT Alarm	ENABL/DISBL		DISBL	
<b>Over power set</b>	Generator Over Power Set	0	9999	0	kVA
<b>Over power prealarm</b>	Generator Over Power Pre-Alarm	0(dis)	9999	dis	kVA
<b>Over power reset</b>	Generator Over Power Pre-Alarm Reset	0	9999	0	kVA
<b>Over load step 1</b>	Generator Over Load Step 1	0	9999	9999	KVA
<b>Over load step 1 rest</b>	Generator Over Load Step 1 Reset	0	9999	9999	KVA
<b>Over load step 2</b>	Generator Over Load Step 2	0	9999	9999	KVA
<b>Over load step 2 rest</b>	Generator Over Load Step 2 Reset	0	9999	9999	KVA
<b>Reverse power set</b>	Reverse Power Set	-9999	0	0	kW

**Note:** dis = disable

## 4.2 Technician Parameters

### 4.2.1 System

<b>SYSTEM NETWORK (System-&gt;Network)</b>		<b>Min</b>	<b>Max</b>	<b>Default</b>	<b>Unit</b>
<b>CT ratio</b>	Current Transformer Ratio	1	9999	100	
<b>Earth fault CT ratio</b>	Earth Fault Current Transformer Ratio	1	9999	100	
<b>PT ratio</b>	Voltage Transformer Ratio	1	100	1	
<b>Type of AC system</b>	Select AC system; 0- 1 Phase 2 Wire 1- 3 Phase 4 Wire 2- 2 Phase 3 Wire L1-L2 3- 2 Phase 3 Wire L1-L3	0	3	1	
<b>Phase sequence</b>	Generator Phase Sequence (dis, L123 or L321)	DISBL, L123, L321		DISBL	
<b>Generator kVA rating</b>	Generator kVA rating set	0	9999	300	kVA
<b>Power unit</b>	Power unit	kVA/kW		kVA	
<b>kVA,kW,kVAr point</b>	kVA, kW, kVAr point position; 0-> 0 1-> 0.0 2-> 0.00 3-> 0.000	0	3	0	
<b>Power on mode</b>	Power On Mode Selection	0-LAST MODE 1-AUTO MODE 2-TEST MODE 3-MANUAL MODE 4-STOP MODE		0-LAST MODE	

<b>BREAKERS (System-&gt;Breakers)</b>		<b>Min</b>	<b>Max</b>	<b>Default</b>	<b>Unit</b>
<b>Type of Breaker</b>	Hardware Breaker Selection	0(dis)	3	1	
<b>Gen.brk.cls.contact</b>	Gen Close Breaker Contact Type	NO / NC		0	
<b>Gen.brk.cls.relay</b>	Gen Close Breaker Relay Type	NOR / PULS		0	
<b>Gen.brk.cls.time</b>	Gen Close Timer	1	250	5	Sec
<b>Gen.brk.open relay</b>	Gen Open Breaker Relay Type	NOR / PULS		0	
<b>Gen.brk.open time</b>	Gen Open Timer	1	250	5	Sec
<b>Break.close puls.time</b>	Breaker Close Pulse Time	0.0	10.0	0.5	Sec
<b>Break.open pulse time</b>	Breaker Open Pulse Time	0.0	10.0	0.5	Sec
<b>Transfer time</b>	Transfer Time	0	250	2	Sec
<b>Spring loading time</b>	Spring Loading Time	1	250	3	Sec
<b>Retry number</b>	Retry Number	1	250	5	

<b>LCD DISPLAY (System-&gt;LCD display)</b>		<b>Min</b>	<b>Max</b>	<b>Default</b>	<b>Unit</b>
<b>Language</b>	Language Selection	ENGLISH/CHINESE		ENGLISH	
<b>Contrast</b>	Contrast Setting	4	9	5	
<b>Auto backlight off</b>	Auto Backlight Off	ENABL/DISBL		DISBL	
<b>Auto scroll time</b>	Auto Scroll Time	0 (dis)	250	0	Sec
<b>Auto scroll number</b>	Auto Scroll Number	1	24	3	
<b>Err. mesg scroll time</b>	Scroll Time For Error Messages	1	250	2	Sec

#### Note:

NO / NC : Normally Open / Normally Close  
 NOR / PULS : Normal / Pulse  
 dis = disable

<b>COMMUNICATION (System-&gt;Communication)</b>		<b>Min</b>	<b>Max</b>	<b>Default</b>	<b>Unit</b>
<b>Slave address</b>	Slave Address	1	247	1	
<b>Baud rate</b>	Baud Rate: 0 - 1200 baud 1 - 2400 baud 2 - 4800 baud 3 - 9600 baud 4 - 19200 baud 5 - 38400 baud	0	5	3	
<b>Parity</b>	Parity: 0-> None, 1-> Odd, 2-> Even	0	2	0	
<b>Stop bit</b>	Stop Bit (0-> 1 stop bit,1-> 2 stop bit)	0	1	0	
<b>Datalog period</b>	Datalog Period	0.0(dis)	999.9	1.0	Min
<b>Timeout</b>	Timeout	0(dis)	999	3	Min
<b>ASCII/RTU selection</b>	ModBus ASCII/RTU Selection	ASCII / RTU		ASCII	

<b>DATE &amp; TIME SET (System-&gt;Date &amp; time set)</b>		<b>Min</b>	<b>Max</b>	<b>Default</b>	<b>Unit</b>
<b>Year</b>	Year	0	99		
<b>Month</b>	Month	1	12		
<b>Day</b>	Date	1	31		
<b>Week</b>	Day of week	1	7		
<b>Hour</b>	Hour	0	23		
<b>Minute</b>	Minute	0	59		
<b>Second</b>	Second	0	59		

<b>DEFAULT SETTINGS (System-&gt;Default settings)</b>		<b>Min</b>	<b>Max</b>	<b>Default</b>	<b>Unit</b>
<b>Save setting to def.</b>	Save setting to default	YES / NO		NO	
<b>Reset default sets</b>	Reset default sets	YES / NO		NO	
<b>Reset factory sets</b>	Reset factory sets	YES / NO		NO	

<b>PASSWORD SETTINGS (System-&gt;Password settings)</b>		<b>Min</b>	<b>Max</b>	<b>Default</b>	<b>Unit</b>
<b>Operator password</b>	Operator Password	0	9999	0	
<b>Technician password</b>	Technician Password	0	9999	0	

**Note:** dis = disable

## 4.2.2 Generator

<b>GENERATOR VOLT LEVEL (<i>Generator-&gt;Volt level</i>)</b>		<b>Min</b>	<b>Max</b>	<b>Default</b>	<b>Unit</b>
<b>Under volt shutdown</b>	Generator Under Voltage Shutdown	60(dis)	600	320	V~
<b>Under volt prealarm</b>	Generator Under Voltage Pre-Alarm	60(dis)	600	340	V~
<b>Under volt reset</b>	Generator Under Voltage Pre-Alarm Reset	60	600	350	V~
<b>Over volt shutdown</b>	Generator Over Voltage Shutdown	60	600	440	V~
<b>Over volt prealarm</b>	Generator Over Voltage Pre-Alarm	60(dis)	600	420	V~
<b>Over volt reset</b>	Generator Over Voltage Pre-Alarm Reset	60	600	400	V~
<b>Shutdown delay time</b>	Generator Voltage Shutdown Delay Time	0.0	10.0	1.0	Sec

<b>GENERATOR FREQ LEVEL (<i>Generator-&gt;Frequency level</i>)</b>		<b>Min</b>	<b>Max</b>	<b>Default</b>	<b>Unit</b>
<b>Nominal frequency</b>	Nominal Alternator Frequency	30.0	75.0	50.0	Hz
<b>Under freq shutdown</b>	Generator Under Frequency Shutdown	30.0(dis)	75.0	43.0	Hz
<b>Under freq prealarm</b>	Generator Under Frequency Pre-Alarm	30.0(dis)	75.0	45.0	Hz
<b>Under freq reset</b>	Generator Under Frequency Pre-Alarm Reset	30.0	75.0	46.0	Hz
<b>Over freq shutdown</b>	Generator Over Frequency Shutdown	30.0(dis)	75.0	58.0	Hz
<b>Over freq prealarm</b>	Generator Over Frequency Pre-Alarm	30.0(dis)	75.0	55.0	Hz
<b>Over freq reset</b>	Generator Over Frequency Pre-Alarm Reset	30.0	75.0	54.0	Hz
<b>Shutdown delay time</b>	Generator Frequency Shutdown Delay Time	0.0	10.0	1.0	Sec

**Note:** dis = disable



<b>GEN CUR LEVEL &amp; ACT (Generator-&gt;Current level &amp; act.)</b>		<b>Min</b>	<b>Max</b>	<b>Default</b>	<b>Unit</b>
<b>Under cur. set</b>	Generator Under Current Set	0	9999	1	A~
<b>Under cur. prealarm</b>	Generator Under Current Pre-Alarm	0(dis)	9999	dis	A~
<b>Under cur. reset</b>	Generator Under Current Pre-Alarm Reset	0	9999	5	A~
<b>Under cur. act.</b>	Generator Under Current Actions 0 - Disable 1 - Warning (Alarm Only, No Shutdown) 2 - Electrical Trip (Alarm/Off Load Generator Followed By Shutdown After Cooling) 3 - Shutdown (Alarm And Shutdown)	0(dis)	3	dis	
<b>Under act. delay time</b>	Generator Under Current Actions Delay Time	0	99	2	Sec
<b>Over cur. IDMT alarm</b>	Generator Over Current IDMT Alarm	ENABL/DISBL		DISBL	
<b>Over cur. set</b>	Generator Over Current Set	0	9999	9999	A~
<b>Over cur. prealarm</b>	Generator Over Current Pre-Alarm	0(dis)	9999	9990	A~
<b>Over cur. reset</b>	Generator Over Current Pre-Alarm Reset	0	9999	9980	A~
<b>Over cur. act.</b>	Generator Over Current Actions 0 - Disable 1 - Warning (Alarm Only, No Shutdown) 2 - Electrical Trip (Alarm/Off Load Generator Followed By Shutdown After Cooling) 3 - Shutdown (Alarm And Shutdown)	0(dis)	3	dis	
<b>Over act. delay time</b>	Generator Over Current Actions Delay Time	0	99	2	Sec
<b>Short circuit cur.</b>	Generator Short Circuit Current Set	0	9999	9999	A~
<b>Earth fault cur.</b>	Generator Earth Fault Current Set	0	9999	100	A~
<b>Earth fault cur. act.</b>	Generator Earth Fault Current Actions 0 - Disable 1 - Warning (Alarm Only, No Shutdown) 2 - Electrical Trip (Alarm/Off Load Generator Followed By Shutdown After Cooling) 3 - Shutdown (Alarm And Shutdown)	0(dis)	3	dis	
<b>E.F. act. delay time</b>	Generator Earth Fault Current Actions Delay Time	0	99	2	Sec
<b>Unbalance load set</b>	Unbalance Load Set	0	9999	0	A~
<b>Unbalance load act.</b>	Unbalance Load Actions 0 - Disable 1 - Warning (Alarm Only, No Shutdown) 2 - Electrical Trip (Alarm/Off Load Generator Followed By Shutdown After Cooling) 3 - Shutdown (Alarm And Shutdown)	0(dis)	3	dis	
<b>Unbalance act. delay</b>	Unbalance Load Actions Delay Time	0	99	2	Sec

**Note:** dis = disable

<b>GEN POWER LEVEL (Generator-&gt;Power level)</b>		<b>Min</b>	<b>Max</b>	<b>Default</b>	<b>Unit</b>
<b>Under power set</b>	Generator Under Power Set	0	9999	0	kVA
<b>Under power prealarm</b>	Generator Under Power Pre-Alarm	0(dis)	9999	dis	kVA
<b>Under power reset</b>	Generator Under Power Pre-Alarm Reset	0	9999	5	kVA
<b>Under power act.</b>	Generator Under Power Actions 0 - Disable 1 - Warning (Alarm Only, No Shutdown) 2 - Electrical Trip (Alarm/Off Load Generator Followed By Shutdown After Cooling) 3 - Shutdown (Alarm And Shutdown)	0(dis)	3	0(dis)	
<b>Under act. delay time</b>	Generator Under Power Action Delay Time	0	99	2	Sec
<b>Over power IDMT alarm</b>	Generator Over Power IDMT Alarm	ENABL/DISBL		DISBL	
<b>Over power set</b>	Generator Over Power Set	0	9999	0	kVA
<b>Over power prealarm</b>	Generator Over Power Pre-Alarm	0(dis)	9999	dis	kVA
<b>Over power reset</b>	Generator Over Power Pre-Alarm Reset	0	9999	0	kVA
<b>Over power act.</b>	Generator Over Power Actions 0 - Disable 1 - Warning (Alarm Only, No Shutdown) 2 - Electrical Trip (Alarm/Off Load Generator Followed By Shutdown After Cooling) 3 - Shutdown (Alarm And Shutdown)	0(dis)	3	0(dis)	
<b>Over act. delay time</b>	Generator Over Power Action Delay Time	0	99	2	Sec
<b>Over load step 1</b>	Generator Over Load Step 1	0	9999	9999	KVA
<b>Over load step 1 rest</b>	Generator Over Load Step 1 Reset	0	9999	9999	KVA
<b>Over load step 1 act.</b>	Generator Over Load Step 1 Actions 0 - Disable 1 - Status 2 - Warning Non-Latching 3 - Warning Latching	0(dis)	3	0(dis)	
<b>Over load step 1 dly.</b>	Generator Over Load Step 1 Action Delay Time	0	999.9	30.0	Sec
<b>Over load step 2</b>	Generator Over Load Step 2	0	9999	9999	KVA
<b>Over load step 2 rest</b>	Generator Over Load Step 2 Reset	0	9999	9999	KVA
<b>Over load step 2 act.</b>	Generator Over Load Step 2 Actions 0 - Disable 1 - Status 2 - Warning Non-Latching 3 - Warning Latching	0(dis)	3	0(dis)	
<b>Over load step 2 dly.</b>	Generator Over Load Step 2 Action Delay Time	0	999.9	30.0	Sec
<b>Reverse power set</b>	Reverse Power Set	-9999	0	0	kW
<b>Reverse power act.</b>	Reverse Power Actions 0 - Disable 1 - Warning (Alarm Only, No Shutdown) 2 - Electrical Trip (Alarm/Off Load Generator Followed By Shutdown After Cooling) 3 - Shutdown (Alarm And Shutdown)	0(dis)	3	0(dis)	
<b>Rv.pow.act.delay time</b>	Reverse Power Action Delay Time	0	99	2	Sec

<b>GENERATOR GENERAL (Generator-&gt;General)</b>		<b>Min</b>	<b>Max</b>	<b>Default</b>	<b>Unit</b>
<b>Sens.option gen.freq</b>	Sensing Options Generator Frq En/Dis	ENABL/DISBL		ENABL	
<b>Sens.opt.pickup&amp;flywh</b>	Sensing Opt Pickup En/Dis & Flywheel	0(dis)	1000	DISBL	
<b>All warning are latch</b>	All Warnings Are Latched En/Dis	ENABL/DISBL		DISBL	
<b>Stop mode on shutdown</b>	Changed To Stop Mode On Shutdown Fail	ENABL/DISBL		DISBL	

**Note:** dis = disable

## 4.2.3 Engine

<b>ENGINE START OPTIONS (<i>Engine-&gt;Starting options</i>)</b>		<b>Min</b>	<b>Max</b>	<b>Default</b>	<b>Unit</b>
<b>Horn prior start</b>	Audible Alarm Prior To Starting En/Dis	ENABL/DISBL		DISBL	
<b>No. of crank attemp</b>	Number Of Start Attempts	1	10	3	
<b>Cranking time</b>	Cranking Time	1	99	5	Sec
<b>Crank rest time</b>	Crank Rest Time	5	99	10	Sec
<b>Pickup fail dely</b>	Pickup Sensor Fail Delay	0.1	10.0	1.0	Sec

<b>ENG. CRANK DISCONNECT (<i>Engine-&gt;Crank disconnect</i>)</b>		<b>Min</b>	<b>Max</b>	<b>Default</b>	<b>Unit</b>
<b>Generator frequency</b>	Crank Disconnect On Gen. Frequency	10.0	75.0	30.0	Hz
<b>Engine speed</b>	Crank Disconnect On Engine RPM	100	6000	500	RPM
<b>Generator volt</b>	Crank Disconnect On Gen. Voltage	60 (dis)	600	300	V $\sim$
<b>Charge alt. volt</b>	Crank Disconnect On Charge Alt. Voltage	6.0 (dis)	30.0	dis	V $\text{---}$
<b>Oil pres. enab./dis.</b>	Crank Disconnect On Oil Pressure En/Dis	ENABL/DISBL		DISBL	
<b>Oil pressure value</b>	Crank Disconnect On Oil Pressure Value	1.0	30.0	1.0	BAR
<b>Check oil befor.start</b>	Check Oil Pressure Before Start	ENABL/DISBL		ENABL	

<b>ENGINE SPEED SETS (<i>Engine-&gt;Speed settings</i>)</b>		<b>Min</b>	<b>Max</b>	<b>Default</b>	<b>Unit</b>
<b>Nominal speed</b>	Nominal Speed	500	5000	1500	RPM
<b>Under speed shutdown</b>	Engine Under Speed Shutdown	500(dis)	5000	dis	RPM
<b>Under speed prealarm</b>	Engine Under Speed Prealarm	500(dis)	5000	dis	RPM
<b>Under speed reset</b>	Engine Under Speed Prealarm Reset	500	5000	500	RPM
<b>Over speed shutdown</b>	Engine Over Speed Shutdown	500(dis)	5000	dis	RPM
<b>Over speed prealarm</b>	Engine Over Speed Prealarm	500(dis)	5000	dis	RPM
<b>Over speed reset</b>	Engine Over Speed Prealarm Reset	500	5000	500	RPM
<b>Shutdown delay time</b>	Engine Speed Shutdown Delay Time	0.0	10.0	1.0	Sec

<b>ENGINE PLANT BATTERY (<i>Engine-&gt;Plant battery</i>)</b>		<b>Min</b>	<b>Max</b>	<b>Default</b>	<b>Unit</b>
<b>Under volt shutdown</b>	Battery Undervolts Shutdown	6.0(dis)	30.0	dis	V $\text{---}$
<b>Under volt warning</b>	Battery Undervolts Warning	6.0(dis)	30.0	11.0	V $\text{---}$
<b>Under volt reset</b>	Battery Undervolts Warning Reset	6.0	30.0	11.5	V $\text{---}$
<b>Under volt delay</b>	Battery Undervolts Volts Delay	0.0	120.0	1.0	Sec
<b>Over volt shutdown</b>	Battery Overvolts Shutdown	6.0(dis)	30.0	dis	V $\text{---}$
<b>Over volt warning</b>	Battery Overvolts Warning	6.0(dis)	30.0	29.0	V $\text{---}$
<b>Over volt reset</b>	Battery Overvolts Warning Reset	6.0	30.0	28.5	V $\text{---}$
<b>Over volt delay</b>	Battery Overvolts Delay	0.0	120.0	1.0	Sec
<b>Alt. chg. warning</b>	Charge Alternator Warning	6.0(dis)	30.0	dis	V $\text{---}$

<b>CANBUS ECU (Engine-&gt;CanBus ECU)</b>		<b>Min</b>	<b>Max</b>	<b>Default</b>	<b>Unit</b>
<b>Baud rate</b>	Baud Rate: 0: 20, 1: 50, 2: 100, 3: 125, 4: 250, 5: 500, 6: 800, 7: 1.000	0	7	4	kBaud
<b>J1939 ECU type</b>	J1939 ECU Type Selection: 0 - Disable 1 - Standard 2 - Volvo EMS1 3 - Volvo EMS2 4 - Volvo EMS2b 5 - Volvo EDC3 6 - Volvo EDC4 7 - Deutz EMR2 8 - Deutz EMR3 9 - Perkins 1300 10 - Perkins ADEM3 11 - Perkins ADEM4 12 - Scania S6 13 - MAN MFR 14 - Cummins ISB 15 - Cummins CM570 16 - Cummins CM850 17 - Cummins CM2150E 18 - Cummins CM2250 19 - Detroit DDEC 20 - John Deere 21 - MTU ADEC 22 - MTU ECU8 23 - MTU ECU8 SAM 24 - Yuchai 25 - Kubota 26 - Baudouin WISE10B 27 - Baudouin WISE15 28 - Perkins 1600 29 - Perkins A4E2 30 - Perkins A5E2 31 - Perkins A5E2v2 32 - Hatz EDC17	0(dis)	32	0	
<b>Device address</b>	Device Address	0	255	17	
<b>SPN version</b>	SPN version	1	3	1	
<b>ECU remote control</b>	ECU Remote Control via J1939	ENABL/DISBL		ENABL	
<b>Speed control enable</b>	Speed Control via J1939	ENABL/DISBL		ENABL	
<b>Oil pres cont. enab</b>	Oil Pressure Control via J1939	ENABL/DISBL		DISBL	
<b>Temp. control enable</b>	Coolant Temperature Control via J1939	ENABL/DISBL		DISBL	
<b>Speed set point</b>	Speed Set Point Selection	1500 / 1800		1500	RPM
<b>Speed correction</b>	Speed Correction Value	0	100	50	%

**Note:** dis = disable

<b>CANBUS ERROR SET (<i>Engine-&gt;CanBus error set</i>)</b>		<b>Min</b>	<b>Max</b>	<b>Default</b>	<b>Unit</b>
<b>CAN fault actions</b>	Can Fault Actions: 0- Disable 1- Warning Non-Latching 2- Warning (Alarm Only, No Shutdown) 3- Electrical Trip (Alarm/Off Load Generator Followed By Shutdown After Cooling) 4- Shutdown (Alarm And Shutdown)	0(dis)	4	0	
<b>CAN fault activation</b>	Can Fault Activation: 0- Active From Starting 1- Active From Safety On 2- Always Active	0	2	0	
<b>CAN fault delay</b>	Can Fault Delay	2	250	10	Sec
<b>Amber warn.actions</b>	J1939 Amber Warning Lamp Actions: 0- Disable 1- Warning Non-Latching 2- Warning (Alarm Only, No Shutdown) 3- Electrical Trip (Alarm/Off Load Generator Followed By Shutdown After Cooling) 4- Shutdown (Alarm And Shutdown)	0(dis)	4	0	
<b>Amber warn.activation</b>	J1939 Amber Warning Lamp Activation: 0- Active From Starting 1- Active From Safety On 2- Always Active	0	2	2	
<b>Amber warn.delay</b>	J1939 Amber Warning Lamp Delay	0	250	2	Sec
<b>Red stop actions</b>	J1939 Red Stop Lamp Actions: 0- Disable 1- Warning Non-Latching 2- Warning (Alarm Only, No Shutdown) 3- Electrical Trip (Alarm/Off Load Generator Followed By Shutdown After Cooling) 4- Shutdown (Alarm And Shutdown)	0(dis)	4	0	
<b>Red stop activation</b>	J1939 Red Stop Lamp Activation: 0- Active From Starting 1- Active From Safety On 2- Always Active	0	2	2	
<b>Red stop delay</b>	J1939 Red Stop Lamp Delay	0	250	2	Sec

**Note:** dis = disable

<b>ENGINE MAINTENANCE (<i>Engine-&gt;Maintenance</i>)</b>		<b>Min</b>	<b>Max</b>	<b>Default</b>	<b>Unit</b>
<b>Running hour interval</b>	Running Hours Interval	0(dis)	9999	5000	Hour
<b>Maint. date interval</b>	Maintenance Date Interval	0(dis)	12	6	Month
<b>Eng. stop when maint</b>	Force Engine Shutdown When Maintenance Is Due	ENABL/DISBL		DISBL	
<b>Engine running hour</b>	Engine Running Hour	0	30000	0	
<b>Maintenance okay</b>	Maintenance Okay	YES/NO		NO	

<b>LOAD TEST (<i>Engine-&gt;Load test</i>)</b>		<b>Min</b>	<b>Max</b>	<b>Default</b>	<b>Unit</b>
<b>Disable/enable select</b>	Disable, No Load or On Load Selection	0-DISABLE 1-NO LOAD 2-ON LOAD		0-DISABLE	

<b>EXERCISE (<i>Engine-&gt;Exercise</i>)</b>		<b>Min</b>	<b>Max</b>	<b>Default</b>	<b>Unit</b>
<b>Disable/enable select</b>	Exercise Disable or Enable	DISBL/ENABL		DISBL	
<b>Start time1 on monday</b>	Exercise Start Time 1 on Monday	0.00	23.59	0.00	H.Min
<b>Stop time1 on monday</b>	Exercise Stop Time 1 on Monday	0.00	23.59	0.00	H.Min
<b>Start time2 on monday</b>	Exercise Start Time 2 on Monday	0.00	23.59	0.00	H.Min
<b>Stop time2 on monday</b>	Exercise Stop Time 2 on Monday	0.00	23.59	0.00	H.Min
<b>Start time3 on monday</b>	Exercise Start Time 3 on Monday	0.00	23.59	0.00	H.Min
<b>Stop time3 on monday</b>	Exercise Stop Time 3 on Monday	0.00	23.59	0.00	H.Min
<b>Start time4 on monday</b>	Exercise Start Time 4 on Monday	0.00	23.59	0.00	H.Min
<b>Stop time4 on monday</b>	Exercise Stop Time 4 on Monday	0.00	23.59	0.00	H.Min
<b>Start time1 on tues.</b>	Exercise Start Time 1 on Tuesday	0.00	23.59	0.00	H.Min
<b>Stop time1 on tuesday</b>	Exercise Stop Time 1 on Tuesday	0.00	23.59	0.00	H.Min
<b>Start time2 on tues.</b>	Exercise Start Time 2 on Tuesday	0.00	23.59	0.00	H.Min
<b>Stop time2 on Tuesday</b>	Exercise Stop Time 2 on Tuesday	0.00	23.59	0.00	H.Min
<b>Start time3 on tues.</b>	Exercise Start Time 3 on Tuesday	0.00	23.59	0.00	H.Min
<b>Stop time3 on tuesday</b>	Exercise Stop Time 3 on Tuesday	0.00	23.59	0.00	H.Min
<b>Start time4 on tues.</b>	Exercise Start Time 4 on Tuesday	0.00	23.59	0.00	H.Min
<b>Stop time4 on tuesday</b>	Exercise Stop Time 4 on Tuesday	0.00	23.59	0.00	H.Min
<b>Start time1 on wednes.</b>	Exercise Start Time 1 on Wednesday	0.00	23.59	0.00	H.Min
<b>Stop time1 on wednes.</b>	Exercise Stop Time 1 on Wednesday	0.00	23.59	0.00	H.Min
<b>Start time2 on wednes.</b>	Exercise Start Time 2 on Wednesday	0.00	23.59	0.00	H.Min
<b>Stop time2 on wednes.</b>	Exercise Stop Time 2 on Wednesday	0.00	23.59	0.00	H.Min
<b>Start time3 on wednes.</b>	Exercise Start Time 3 on Wednesday	0.00	23.59	0.00	H.Min
<b>Stop time3 on wednes.</b>	Exercise Stop Time 3 on Wednesday	0.00	23.59	0.00	H.Min
<b>Start time4 on wednes.</b>	Exercise Start Time 4 on Wednesday	0.00	23.59	0.00	H.Min
<b>Stop time4 on wednes.</b>	Exercise Stop Time 4 on Wednesday	0.00	23.59	0.00	H.Min
<b>Start time1 on thurs.</b>	Exercise Start Time 1 on Thursday	0.00	23.59	0.00	H.Min
<b>Stop time1 on thurs.</b>	Exercise Stop Time 1 on Thursday	0.00	23.59	0.00	H.Min
<b>Start time2 on thurs.</b>	Exercise Start Time 2 on Thursday	0.00	23.59	0.00	H.Min
<b>Stop time2 on thurs.</b>	Exercise Stop Time 2 on Thursday	0.00	23.59	0.00	H.Min
<b>Start time3 on thurs.</b>	Exercise Start Time 3 on Thursday	0.00	23.59	0.00	H.Min
<b>Stop time3 on thurs.</b>	Exercise Stop Time 3 on Thursday	0.00	23.59	0.00	H.Min
<b>Start time4 on thurs.</b>	Exercise Start Time 4 on Thursday	0.00	23.59	0.00	H.Min
<b>Stop time4 on thurs.</b>	Exercise Stop Time 4 on Thursday	0.00	23.59	0.00	H.Min

**Note:** dis = disable

<b>Start time1 on friday</b>	Exercise Start Time 1 on Friday	0.00	23.59	0.00	H.Min
<b>Stop time1 on friday</b>	Exercise Stop Time 1 on Friday	0.00	23.59	0.00	H.Min
<b>Start time2 on friday</b>	Exercise Start Time 2 on Friday	0.00	23.59	0.00	H.Min
<b>Stop time2 on friday</b>	Exercise Stop Time 2 on Friday	0.00	23.59	0.00	H.Min
<b>Start time3 on friday</b>	Exercise Start Time 3 on Friday	0.00	23.59	0.00	H.Min
<b>Stop time3 on friday</b>	Exercise Stop Time 3 on Friday	0.00	23.59	0.00	H.Min
<b>Start time4 on friday</b>	Exercise Start Time 4 on Friday	0.00	23.59	0.00	H.Min
<b>Stop time4 on friday</b>	Exercise Stop Time 4 on Friday	0.00	23.59	0.00	H.Min
<b>Start time1 on satur.</b>	Exercise Start Time 1 on Saturday	0.00	23.59	0.00	H.Min
<b>Stop time1 on satur.</b>	Exercise Stop Time 1 on Saturday	0.00	23.59	0.00	H.Min
<b>Start time2 on satur.</b>	Exercise Start Time 2 on Saturday	0.00	23.59	0.00	H.Min
<b>Stop time2 on satur.</b>	Exercise Stop Time 2 on Saturday	0.00	23.59	0.00	H.Min
<b>Start time3 on satur.</b>	Exercise Start Time 3 on Saturday	0.00	23.59	0.00	H.Min
<b>Stop time3 on satur.</b>	Exercise Stop Time 3 on Saturday	0.00	23.59	0.00	H.Min
<b>Start time4 on satur.</b>	Exercise Start Time 4 on Saturday	0.00	23.59	0.00	H.Min
<b>Stop time4 on satur.</b>	Exercise Stop Time 4 on Saturday	0.00	23.59	0.00	H.Min
<b>Start time1 on sunday</b>	Exercise Start Time 1 on Sunday	0.00	23.59	0.00	H.Min
<b>Stop time1 on sunday</b>	Exercise Stop Time 1 on Sunday	0.00	23.59	0.00	H.Min
<b>Start time2 on sunday</b>	Exercise Start Time 2 on Sunday	0.00	23.59	0.00	H.Min
<b>Stop time2 on sunday</b>	Exercise Stop Time 2 on Sunday	0.00	23.59	0.00	H.Min
<b>Start time3 on sunday</b>	Exercise Start Time 3 on Sunday	0.00	23.59	0.00	H.Min
<b>Stop time3 on sunday</b>	Exercise Stop Time 3 on Sunday	0.00	23.59	0.00	H.Min
<b>Start time4 on sunday</b>	Exercise Start Time 4 on Sunday	0.00	23.59	0.00	H.Min
<b>Stop time4 on sunday</b>	Exercise Stop Time 4 on Sunday	0.00	23.59	0.00	H.Min

<b>ENGINE GENERAL (Engine-&gt;General)</b>		<b>Min</b>	<b>Max</b>	<b>Default</b>	<b>Unit</b>
<b>Fuel selection</b>	Engine Fuel Selection	0-GAS 1-DIESEL 2-GASOLINE		1-DIESEL	
<b>Stop solenoid time</b>	Stop Solenoid Time	1	99	20	Sec
<b>Ignition delay</b>	Ignition Delay	1	99	5	Sec
<b>Gas valve delay</b>	Gas Valve Delay	1	99	5	Sec
<b>Min. of ignition speed</b>	Minimum Ignition Speed	10	1500	200	RPM
<b>Choke time</b>	Choke Time	0.0	30.0	0.8	Sec

**Note:** dis = disable

## 4.2.4 Inputs

<b>SENDER INPUTS (<i>Inputs-&gt;Sender inputs</i>)</b>		<b>Min</b>	<b>Max</b>	<b>Default</b>	<b>Unit</b>
<b>Oil pressure unit</b>	Oil Pressure Unit	<b>BAR/PSI/KPA</b>		<b>BAR</b>	
<b>Oil press. input type</b>	Oil Pressure Input Type	0 - Not Used (Disable) 1 - Digital NC 2 - Digital NO 3 - VDO 5 BAR 4 - VDO 7 BAR 5 - VDO 10 BAR 6 - DATCON 5 BAR 7 - DATCON 7 BAR 8 - MURPHY 7 BAR 9 - User Configured		0 (dis)	
<b>Oil pressure prealarm</b>	Oil Pressure Pre-Alarm	0.0 (dis)	30.0	1.2	BAR
<b>Oil pressure reset</b>	Oil Pressure Pre-Alarm Reset	0.0	30.0	1.4	BAR
<b>Oil pressure shutdown</b>	Oil Pressure Shutdown	0.0	30.0	1.0	BAR
<b>Temperature unit</b>	Coolant Temperature Unit	<b>°C/°F</b>		<b>°C</b>	
<b>Temp. input type</b>	Coolant Temperature Input Type	0 - Not Used (Disable) 1 - Digital NC 2 - Digital NO 3 - VDO 120 °C 4 - VDO 150 °C 5 - DATCON 6 - MURPHY 7 - PT100 8 - User Configured		0 (dis)	
<b>Temp. sensor break</b>	Temperature Sensor Break	0 - Disable 1 - Enable From Safety On (3min. delayed) 2 - Always Enable		0 (dis)	
<b>High temp. prealarm</b>	High Temperature Pre-Alarm	0 (dis)	300	90	°C
<b>High temp. reset</b>	High Temp. Pre-Alarm Reset	0	300	88	°C
<b>High temp. shutdown</b>	High Temperature Shutdown	0	300	95	°C
<b>Low temp. warning</b>	Low Temperature Warning	0 (dis)	70	0 (dis)	°C
<b>Heater control ON</b>	Coolant Heater Control On	0 (dis)	300	0 (dis)	°C
<b>Heater control OFF</b>	Coolant Heater Control Off	0	300	45	°C
<b>Water pump on time</b>	Water Pump On Time	0	9999	5	Sec
<b>Water pump off time</b>	Water Pump Off Time	0	9999	5	Sec
<b>Conf. AI1 unit</b>	Configurable Analog Input-1 Unit	BAR/PSI/KPA/°C/°F/%/Lt		%	
<b>Conf. AI1 type</b>	Configurable Analog Input-1 Type	0 - Not Used (Disable) 1 - Digital NC 2 - Digital NO 3 - VDO OHM (10-180) 4 - VDO TUBE (90-0) 5 - US OHM (240-33) 6 - ELS11 OHM (0-190) 7 - FORD (73-10) 8 - ELS13 OHM (0-190) 9 - ELS30 OHM (0-190) 10 - User Configured		0 (dis)	
<b>Conf. AI1 indication</b>	If Conf. AI1 type is "Digital" 0- Status 1- Warning Non-Latching 2- Warning Latching 3- Electrical Trip 4- Shutdown	0	4	0	



<b>Conf. AI1 activation</b>	If Conf. AI1 type is "Digital" 0- Active From Starting 1- Active From Safety On 2- Always Active	0	2	2	
<b>Conf. AI1 active dely</b>	Configurable Analog Input-1 Active Delay (If Conf. AI1 type is "Digital")	0	250	0	Sec
<b>Conf. AI1 low prealarm</b>	Config. Analog Input-1 Low Pre-Alarm	0 (dis)	3000	0 (dis)	%
<b>Conf. AI1 low reset</b>	Config. Analog Input-1 Low Reset	0	3000	60	%
<b>Conf. AI1 low shutdwn</b>	Config. Analog Input-1 Low Shutdown	0 (dis)	3000	0 (dis)	%
<b>Conf. AI1 high prealar</b>	Config. Analog Input-1 High Pre-Alarm	0 (dis)	3000	0 (dis)	%
<b>Conf. AI1 high reset</b>	Config. Analog Input-1 High Reset	0	3000	90	%
<b>Conf. AI1 high shutd.</b>	Config. Analog Input-1 High Shutdown	0 (dis)	3000	0 (dis)	%
<b>Conf. AI1 control ON</b>	Config. Analog Input-1 control ON	0 (dis)	3000	0 (dis)	%
<b>Conf. AI1 control OFF</b>	Config. Analog Input-1 control OFF	0	3000	75	%
<b>Fuel filling max.time</b>	Fuel Filling Maximum Time	0 (dis)	30000	0 (dis)	Sec
<b>Fuel fill.alarm reset</b>	Fuel Filling Alarm Reset	YES/NO		NO	
<b>Fuel consumpt. reset</b>	Fuel Consumption Reset	YES/NO		NO	
<b>Conf. AI2 unit</b>	Configurable Analog Input-2 Unit	BAR/PSI/KPA/°C/°F%/Lt		°C	
<b>Conf. AI2 type</b>	Configurable Analog Input-2 Type	0 - Not Used (Disable) 1 - Digital NC 2 - Digital NO 3 - VDO 120 °C 4 - VDO 150 °C 5 - DATCON 6 - MURPHY 7 - PT100 8 - User Configured		0 (dis)	
<b>Conf. AI2 indication</b>	If Conf. AI2 type is "Digital" 0- Status 1- Warning Non-Latching 2- Warning Latching 3- Electrical Trip 4- Shutdown	0	4	0	
<b>Conf. AI2 activation</b>	If Conf. AI2 type is "Digital" 0- Active From Starting 1- Active From Safety On 2- Always Active	0	2	2	
<b>Conf. AI2 active dely</b>	Configurable Analog Input-2 Active Delay (If Conf. AI2 type is "Digital")	0	250	0	Sec
<b>Conf. AI2 low prealarm</b>	Config. Analog Input-2 Low Pre-Alarm	0 (dis)	300	0 (dis)	°C
<b>Conf. AI2 low reset</b>	Config. Analog Input-2 Low Reset	0	300	60	°C
<b>Conf. AI2 low shutdwn</b>	Config. Analog Input-2 Low Shutdown	0 (dis)	300	0 (dis)	°C
<b>Conf. AI2 high prealar</b>	Config. Analog Input-2 High Pre-Alarm	0 (dis)	300	0 (dis)	°C
<b>Conf. AI2 high reset</b>	Config. Analog Input-2 High Reset	0	300	90	°C
<b>Conf. AI2 high shutd.</b>	Config. Analog Input-2 High Shutdown	0 (dis)	300	0 (dis)	°C
<b>Conf. AI2 control ON</b>	Config. Analog Input-2 Control ON	0 (dis)	300	0 (dis)	°C
<b>Conf. AI2 control OFF</b>	Config. Analog Input-2 Control OFF	0	300	75	°C

**Note:** dis = disable

<b>SENDER LINEARISATION (<i>Inputs-&gt;Sender linearisation</i>)</b>		<b>Min</b>	<b>Max</b>	<b>Default</b>	<b>Unit</b>
<b>Oil pressure sender 1</b>	Oil Pressure Sender Point-1	0	1300	15	R
<b>Oil pressure 1</b>	Oil Pressure Point-1	0.0	30.0	0.0	BAR
<b>Oil pressure sender 2</b>	Oil Pressure Sender Point-2	0	1300	31	R
<b>Oil pressure 2</b>	Oil Pressure Point-2	0.0	30.0	1.0	BAR
<b>Oil pressure sender 3</b>	Oil Pressure Sender Point-3	0	1300	49	R
<b>Oil pressure 3</b>	Oil Pressure Point-3	0.0	30.0	2.0	BAR
<b>Oil pressure sender 4</b>	Oil Pressure Sender Point-4	0	1300	66	R
<b>Oil pressure 4</b>	Oil Pressure Point-4	0.0	30.0	3.0	BAR
<b>Oil pressure sender 5</b>	Oil Pressure Sender Point-5	0	1300	85	R
<b>Oil pressure 5</b>	Oil Pressure Point-5	0.0	30.0	4.0	BAR
<b>Oil pressure sender 6</b>	Oil Pressure Sender Point-6	0	1300	101	R
<b>Oil pressure 6</b>	Oil Pressure Point-6	0.0	30.0	5.0	BAR
<b>Oil pressure sender 7</b>	Oil Pressure Sender Point-7	0	1300	117	R
<b>Oil pressure 7</b>	Oil Pressure Point-7	0.0	30.0	6.0	BAR
<b>Oil pressure sender 8</b>	Oil Pressure Sender Point-8	0	1300	132	R
<b>Oil pressure 8</b>	Oil Pressure Point-8	0.0	30.0	7.0	BAR
<b>Oil pressure sender 9</b>	Oil Pressure Sender Point-9	0	1300	149	R
<b>Oil pressure 9</b>	Oil Pressure Point-9	0.0	30.0	8.0	BAR
<b>Oil pressure sender 10</b>	Oil Pressure Sender Point-10	0	1300	178	R
<b>Oil pressure 10</b>	Oil Pressure Point-10	0.0	30.0	10.0	BAR
<b>Temperature sender 1</b>	Temperature Sender Point-1	0	1300	579	R
<b>Temperature 1</b>	Temperature Point-1	0	300	28	°C
<b>Temperature sender 2</b>	Temperature Sender Point-2	0	1300	404	R
<b>Temperature 2</b>	Temperature Point-2	0	300	35	°C
<b>Temperature sender 3</b>	Temperature Sender Point-3	0	1300	342	R
<b>Temperature 3</b>	Temperature Point-3	0	300	40	°C
<b>Temperature sender 4</b>	Temperature Sender Point-4	0	1300	250	R
<b>Temperature 4</b>	Temperature Point-4	0	300	50	°C
<b>Temperature sender 5</b>	Temperature Sender Point-5	0	1300	179	R
<b>Temperature 5</b>	Temperature Point-5	0	300	60	°C
<b>Temperature sender 6</b>	Temperature Sender Point-6	0	1300	136	R
<b>Temperature 6</b>	Temperature Point-6	0	300	70	°C
<b>Temperature sender 7</b>	Temperature Sender Point-7	0	1300	103	R
<b>Temperature 7</b>	Temperature Point-7	0	300	80	°C
<b>Temperature sender 8</b>	Temperature Sender Point-8	0	1300	77	R
<b>Temperature 8</b>	Temperature Point-8	0	300	90	°C
<b>Temperature sender 9</b>	Temperature Sender Point-9	0	1300	67	R
<b>Temperature 9</b>	Temperature Point-9	0	300	95	°C
<b>Temperature sender 10</b>	Temperature Sender Point-10	0	1300	63	R
<b>Temperature 10</b>	Temperature Point-10	0	300	98	°C
<b>Conf. AI1 sender 1</b>	Configurable Analog Input-1 Sender Point-1	0	1300	10	R
<b>Conf. AI1 value 1</b>	Configurable Analog Input-1 Point-1	0	3000	0	%
<b>Conf. AI1 sender 2</b>	Configurable Analog Input-1 Sender Point-2	0	1300	30	R
<b>Conf. AI1 value 2</b>	Configurable Analog Input-1 Point-2	0	3000	11	%
<b>Conf. AI1 sender 3</b>	Configurable Analog Input-1 Sender Point-3	0	1300	50	R
<b>Conf. AI1 value 3</b>	Configurable Analog Input-1 Point-3	0	3000	22	%
<b>Conf. AI1 sender 4</b>	Configurable Analog Input-1 Sender Point-4	0	1300	70	R
<b>Conf. AI1 value 4</b>	Configurable Analog Input-1 Point-4	0	3000	33	%
<b>Conf. AI1 sender 5</b>	Configurable Analog Input-1 Sender Point-5	0	1300	90	R
<b>Conf. AI1 value 5</b>	Configurable Analog Input-1 Point-5	0	3000	44	%

Conf. AI1 sender 6	Configurable Analog Input-1 Sender Point-6	0	1300	110	R
Conf. AI1 value 6	Configurable Analog Input-1 Point-6	0	3000	55	%
Conf. AI1 sender 7	Configurable Analog Input-1 Sender Point-7	0	1300	130	R
Conf. AI1 value 7	Configurable Analog Input-1 Point-7	0	3000	66	%
Conf. AI1 sender 8	Configurable Analog Input-1 Sender Point-8	0	1300	150	R
Conf. AI1 value 8	Configurable Analog Input-1 Point-8	0	3000	77	%
Conf. AI1 sender 9	Configurable Analog Input-1 Sender Point-9	0	1300	170	R
Conf. AI1 value 9	Configurable Analog Input-1 Point-9	0	3000	88	%
Conf. AI1 sender 10	Configurable Analog Input-1 Sender Point-10	0	1300	190	R
Conf. AI1 value 10	Configurable Analog Input-1 Point-10	0	3000	100	%
Conf. AI2 sender 1	Configurable Analog Input-2 Sender Point-1	0	1300	579	R
Conf. AI2 value 1	Configurable Analog Input-2 Point-1	0	300	28	°C
Conf. AI2 sender 2	Configurable Analog Input-2 Sender Point-2	0	1300	404	R
Conf. AI2 value 2	Configurable Analog Input-2 Point-2	0	300	35	°C
Conf. AI2 sender 3	Configurable Analog Input-2 Sender Point-3	0	1300	342	R
Conf. AI2 value 3	Configurable Analog Input-2 Point-3	0	300	40	°C
Conf. AI2 sender 4	Configurable Analog Input-2 Sender Point-4	0	1300	250	R
Conf. AI2 value 4	Configurable Analog Input-2 Point-4	0	300	50	°C
Conf. AI2 sender 5	Configurable Analog Input-2 Sender Point-5	0	1300	179	R
Conf. AI2 value 5	Configurable Analog Input-2 Point-5	0	300	60	°C
Conf. AI2 sender 6	Configurable Analog Input-2 Sender Point-6	0	1300	136	R
Conf. AI2 value 6	Configurable Analog Input-2 Point-6	0	300	70	°C
Conf. AI2 sender 7	Configurable Analog Input-2 Sender Point-7	0	1300	103	R
Conf. AI2 value 7	Configurable Analog Input-2 Point-7	0	300	80	°C
Conf. AI2 sender 8	Configurable Analog Input-2 Sender Point-8	0	1300	77	R
Conf. AI2 value 8	Configurable Analog Input-2 Point-8	0	300	90	°C
Conf. AI2 sender 9	Configurable Analog Input-2 Sender Point-9	0	1300	67	R
Conf. AI2 value 9	Configurable Analog Input-2 Point-9	0	300	95	°C
Conf. AI2 sender 10	Configurable Analog Input-2 Sender Point-10	0	1300	63	R
Conf. AI2 value 10	Configurable Analog Input-2 Point-10	0	300	98	°C

<b>CONF. INPUT-X (Inputs-&gt;Conf. input-x)</b>		<b>Min</b>	<b>Max</b>	<b>Default</b>	<b>Unit</b>
<b>Dis,user conf.or list</b>	0- Disable 1- User Configured 2- Select From List	0(dis)	2	in1, 2=2 3=1 in4, 5=2 in6=1	
<b>Polarity</b>	0- Normally Open (Close To Activate) 1- Normally Close (Open To Activate)	0	1	in1, 3=1 in2, 4=0 in5, 6=0	
<b>Indication</b>	If User Configured 0- Status 1- Warning Non-Latching 2- Warning Latching 3- Electrical Trip 4- Shutdown	0	4	in1=0 in2=0 in3=4 in4=0 in5=0 in6=0	
<b>Activation</b>	If User Configured 0- Active From Starting 1- Active From Safety On 2- Always Active	0	2	in1, 2=2 in3, 4=2 in5, 6=2	
<b>Select from list</b>	If Select From List 0-Remote Start On Load 1-Remote Start Off Load 2-Reserved 3-Simulate Lamp Test Button 4-Simulate Horn Reset Button 5-Simulate Alarm Reset Button 6-Simulate Auto Button 7-Simulate Test Button 8-Simulate Manual Button 9-Simulate Start Button 10-Simulate Stop Button 11-Generator Closed Auxiliary 12-Generator Load Inhibit 13-Reserved 14-Reserved 15-Auto Restore Inhibit 16-Auto Start Inhibit 17-Panel Lock 18-Scheduled Runs(Exercise) Inhibited 19-Priority Select 20-Transfer To Generator/Open Mains 21-Reserved 22-Remote Inhibit 23-Being Found Alive 24-Reserved 25-Emergency Stop (for only input-1) 25-Sprinkler Mode On Load (for only input-2,3,6) 25-Low Oil Pressure (for only input-4) 25-High Temperature (for only input-5) 26-Low Oil Level (for only input-4) 26-Emergency Stop No-Latching (for only input-1) 26-Sprinkler Mode Off Load (for only input-2,3,6)	0	in1=26 in2=26 in3=26 in4=26 in5=25 In6=26	in1=25 in2=0 in3=4 in4=25 in5=25 in6=7	
<b>Active delay</b>	Input active delay	0	250	in1, 2=0 in3=5 in4, 5=0 in6=5	Sec

**Note-1** : x = 1(input-1), 2(input-2), 3(input-3), 4(input-4), 5(input-5), or 6(input-6)

**Note-2** : 25 - Emergency Stop (for only input-1)  
25 - Low Oil Pressure (for only input-4)  
25 - Sprinkler Mode On Load (for only input-2,3,6)  
25 - High Temperature (for only input-5)  
26 - Low Oil Level (for only input-4)  
26 - Emergency Stop No-Latching (for only input-1)  
26 - Sprinkler Mode Off Load (for only input-2,3,6)

**Note-3** : dis = disable

<b>CONF. INPUT-7 (Inputs-&gt;Conf. input-7)</b>		<b>Min</b>	<b>Max</b>	<b>Default</b>	<b>Unit</b>
<b>Input type</b>	0- Disable 1- User Configured (Digital) 2- Select From List (Digital) 3- Cabin Temperature (Anolog)	0(dis)	3	3	
<b>Polarity</b>	If Input Type is Digital 0- Normally Open (Close To Activate) 1- Normally Close (Open To Activate)	0	1	0	
<b>Indication</b>	If Input Type is User Configured 0- Status 1- Warning Non-Latching 2- Warning Latching 3- Electrical Trip 4- Shutdown	0	4	0	
<b>Activation</b>	If Input Type is User Configured 0- Active From Starting 1- Active From Safety On 2- Always Active	0	2	2	
<b>Select from list</b>	If Input Type is Select From List 0-Remote Start On Load 1-Remote Start Off Load 2-Reserved 3-Simulate Lamp Test Button 4-Simulate Horn Reset Button 5-Simulate Alarm Reset Button 6-Simulate Auto Button 7-Simulate Test Button 8-Simulate Manual Button 9-Simulate Start Button 10-Simulate Stop Button 11-Generator Closed Auxiliary 12-Generator Load Inhibit 13-Reserved 14-Reserved 15-Auto Restore Inhibit 16-Auto Start Inhibit 17-Panel Lock 18-Scheduled Runs(Exercise) Inhibited 19-Priority Select 20-Transfer To Generator/Open Mains 21-Reserved 22-Remote Inhibit 23-Being Found Alive 24-Reserved 25-Sprinkler Mode On Load 26-Sprinkler Mode Off Load	0	26	8	
<b>Active delay</b>	Input active delay (If Input Type is Digital)	0	250	5	Sec
<b>Cabin temp.low prealr</b>	Cabin temperature low prealarm	-50(dis)	100	dis	°C
<b>Cabin temp.low reset</b>	Cabin temperature low prealarm reset	-50	100	0	°C
<b>Cabin temp.low shutd.</b>	Cabin temperature low shutdown	-50(dis)	100	dis	°C
<b>Cabin temp.high preal</b>	Cabin temperature high prealarm reset	-50(dis)	100	dis	°C
<b>Cabin temp.high reset</b>	Cabin temperature high prealarm	-50	100	0	°C
<b>Cabin temp.high shutd</b>	Cabin temperature high shutdown	-50(dis)	100	dis	°C

**Note:** dis = disable

<b>CONF. EXP. INPUT-X (Inputs-&gt;Conf. exp. input-x)</b>		<b>Min</b>	<b>Max</b>	<b>Default</b>	<b>Unit</b>
<b>Dis,user conf.or list</b>	0- Disable 1- User Configured 2- Select From List	0(dis)	2	1	
<b>Hardware type</b>	0-> -Ve (Switched To Battery -) 1-> +Ve (Switched To Battery +)	0	1	0	
<b>Polarity</b>	0- Normally Open (Close To Activate) 1- Normally Close (Open To Activate)	0	1	0	
<b>Indication</b>	If User Configured 0- Status 1- Warning Non-Latching 2- Warning Latching 3- Electrical Trip 4- Shutdown	0	4	0	
<b>Activation</b>	If User Configured 0- Active From Starting 1- Active From Safety On 2- Always Active	0	2	2	
<b>Select from list</b>	If Select From List 2-Reserved 3-Simulate Lamp Test Button 4-Simulate Horn Reset Button 5-Simulate Alarm Reset Button 6-Simulate Auto Button 7-Simulate Test Button 8-Simulate Manual Button 9-Simulate Start Button 10-Simulate Stop Button 11-Generator Closed Auxiliary 12-Generator Load Inhibit 13-Reserved 14-Reserved 15-Auto Restore Inhibit 16-Auto Start Inhibit 17-Panel Lock 18-Scheduled Runs Inhibited 19-Priority Select 20-Transfer To Generator/Open Mains 21-Reserved	2	21	2	
<b>Active delay</b>	Input active delay	0	250	5	Sec

**Note-1** : x = 1(exp. input-1), 2(exp. input-2), 3(exp. input-3), 4(exp. input-4), 5(exp. input-5), 6(exp. input-6), 7(exp. input-7) or 8(exp. input-8)

**Note-2** : dis = disable

## 4.2.5 Outputs

CONF. OUTPUT-1 (Outputs->Conf. output-1)		Min	Max	Default	Unit
<b>Polarity</b>	0- Normally Open (Close To Activate) 1- Normally Close (Open To Activate)	0	1	0	
<b>Function</b>	0-NOT USED 1-AIR FLAP CONTROL 2-ALARM RESET 3-AUDIBLE ALARM 4-AUTO START INHIBIT 5-RESERVED 6-BATTERY HIGH VOLTAGE 7-BATTERY LOW VOLTAGE 8-CALLING FOR SCHEDULED RUN(EXERCISE) 9-CAN ECU POWER 10-CAN ECU STOP 11-CHARGE ALTERNATOR FAILURE 12-COMMON ALARM 13-COMMON ELECTRICAL TRIP ALARM 14-COMMON SHUTDOWN ALARM 15-COMMON WARNING ALARM 16-COOLING FAN AFTER START 17-COOLING FAN AFTER STOP 18-COOLANT TEMPERATURE HIGH PRE-ALARM 19-COOLANT TEMPERATURE HIGH SHUTDOWN 20-COOLING DOWN TIMER IN PROGRESS 21-CRANK RELAY ENERGISED 22-DELAYED ALARMS ACTIVE 23-DIGITAL INPUT1 ALARM 24-DIGITAL INPUT2 ALARM 25-DIGITAL INPUT3 ALARM 26-DIGITAL INPUT4 ALARM 27-DIGITAL INPUT5 ALARM 28-DIGITAL INPUT6 ALARM 29-DIGITAL INPUT7 ALARM 30-EXPANSION INPUT1 ALARM 31-EXPANSION INPUT2 ALARM 32-EXPANSION INPUT3 ALARM 33-EXPANSION INPUT4 ALARM 34-EXPANSION INPUT5 ALARM 35-EXPANSION INPUT6 ALARM 36-EXPANSION INPUT7 ALARM 37-EXPANSION INPUT8 ALARM 38-EARTH FAULT 39-EMERGENCY STOP 40-FAIL TO START ALARM 41-FAIL TO STOP ALARM 42-CONF. A11 CONTROL 43-FUEL RELAY ENERGISED 44-GAS ENGINE IGNITION OUTPUT 45-GENERATOR AT REST 46-GENERATOR AVAILABLE 47-GENERATOR CLOSED AUXILIARY 48-GENERATOR FAILED TO CLOSE 49-GENERATOR FAILED TO OPEN 50-GENERATOR HIGH FREQUENCY PRE-ALARM 51-GENERATOR HIGH FREQUENCY SHUTDOWN 52-GENERATOR HIGH VOLTAGE PRE-ALARM 53-GENERATOR HIGH VOLTAGE SHUTDOWN 54-GENERATOR LOAD INHIBIT 55-GENERATOR LOW FREQUENCY PRE-ALARM 56-GENERATOR LOW FREQUENCY SHUTDOWN 57-GENERATOR LOW VOLTAGE PRE-ALARM 58-GENERATOR LOW VOLTAGE SHUTDOWN 59-GENERATOR STOPPING 60-GENERATOR OPEN BREAKER 61-HORN OUTPUT LATCHED 62-HORN OUTPUT PULSED 63-LAMP TEST 64-CONF. A12 CONTROL 65-LOSS OF MAGNETIC PICK-UP SPEED SIGNAL 66-LOW TEMPERATURE 67-MAINTENANCE DUE ALARM 68-RESERVED 69-RESERVED 70-RESERVED 71-RESERVED 72-RESERVED 73-RESERVED 74-RESERVED 75-RESERVED 76-RESERVED 77-RESERVED 78-NO LOADING COMMAND 79-OIL PRESSURE LOW PRE-ALARM 80-OIL PRESSURE LOW SHUTDOWN 81-CONF. A11 HIGH PREA 82-CONF. A11 HIGH SHUT 83-OVER CURRENT PRE-ALARM 84-OVER CURRENT 85-OVER POWER PRE-ALARM 86-OVER POWER SHUTDOWN 87-OVER SPEED PRE-ALARM 88-OVER SPEED SHUTDOWN 89-PANEL LOCK 90-PRE-HEAT(during preheat timer) 91-PRE-HEAT(until end of cranking) 92-PRE-HEAT(until end of warming) 93-PRE-HEAT(until end safety on) 94-REMOTE START PRESENT 95-REMOTE STOP DELAY IN PROGRESS 96-SHORT CIRCUIT 97-SMOKE LIMITING 98-STARTING ALARM 99-STARTING ALARMS ARMED 100-STOP RELAY ENERGISED 101-SYSTEM IN AUTO MODE 102-SYSTEM IN MANUAL MODE 103-SYSTEM IN STOP MODE 104-SYSTEM IN TEST MODE 105-UNDER CURRENT PRE-ALARM 106-UNDER CURRENT 107-UNDER POWER PRE-ALARM 108-UNDER POWER SHUTDOWN 109-UNDERSPEED PRE-ALARM 110-UNDERSPEED SHUTDOWN 111-WAITING FOR GENERATOR 112-DUAL COMMUNICATION ERROR 113-LOAD SUPPLY FROM GENERATOR 114-RESERVED 115-CONFIGURABLE ANALOG INPUT 1 LOW PRE-ALARM 116-CONFIGURABLE ANALOG INPUT 1 LOW SHUTDOWN 117-CONFIGURABLE ANALOG INPUT 2 LOW PRE-ALARM 118-CONFIGURABLE ANALOG INPUT 2 LOW SHUTDOWN 119-CONFIGURABLE ANALOG INPUT 2 HIGH PRE-ALARM 120-CONFIGURABLE ANALOG INPUT 2 HIGH SHUTDOWN 121-CHOKE ACTIVE 122-REMOTE CONTROL ACTIVE 123-REVERSE POWER 124-CABIN TEMPERATURE LOW PRE-ALARM 125-CABIN TEMPERATURE LOW SHUTDOWN 126-CABIN TEMPERATURE HIGH PRE-ALARM 127-CABIN TEMPERATURE HIGH SHUTDOWN 128-HEATER CONTROL 129-REMOTE OUTPUT 130-UNBALANCE LOAD 131-WATER PUMP 132-RESERVED 133-RESERVED 134-RESERVED 135-RESERVED 136-RESERVED 137-OVER LOAD STEP 1 138-OVER LOAD STEP 2	0	138	43	

<b>CONF. OUTPUT-2 (Outputs-&gt;Conf. output-2)</b>		<b>Min</b>	<b>Max</b>	<b>Default</b>	<b>Unit</b>
<b>Polarity</b>	0- Normally Open (Close To Activate) 1- Normally Close (Open To Activate)	0	1	0	
<b>Function</b>	The same as Configurable Output-1 options	0	138	21	

<b>CONF. OUTPUT-3 (Outputs-&gt;Conf. output-3)</b>		<b>Min</b>	<b>Max</b>	<b>Default</b>	<b>Unit</b>
<b>Polarity</b>	0- Normally Open (Close To Activate) 1- Normally Close (Open To Activate)	0	1	0	
<b>Function</b>	The same as Configurable Output-1 options	0	138	62	

<b>CONF. OUTPUT-4 (Outputs-&gt;Conf. output-4)</b>		<b>Min</b>	<b>Max</b>	<b>Default</b>	<b>Unit</b>
<b>Polarity</b>	0- Normally Open (Close To Activate) 1- Normally Close (Open To Activate)	0	1	0	
<b>Function</b>	The same as Configurable Output-1 options	0	138	9	

<b>CONF. OUTPUT-5 (Outputs-&gt;Conf. output-5)</b>		<b>Min</b>	<b>Max</b>	<b>Default</b>	<b>Unit</b>
<b>Polarity</b>	0- Normally Open (Close To Activate) 1- Normally Close (Open To Activate)	0	1	0	
<b>Function</b>	The same as Configurable Output-1 options	0	138	10	

<b>CONF. OUTPUT-6 (Outputs-&gt;Conf. output-6)</b>		<b>Min</b>	<b>Max</b>	<b>Default</b>	<b>Unit</b>
<b>Polarity</b>	0- Normally Open (Close To Activate) 1- Normally Close (Open To Activate)	0	1	0	
<b>Function</b>	The same as Configurable Output-1 options	0	138	46	

<b>CONF. EXP. OUTPUT-1 (Outputs-&gt;Conf. exp. output-1)</b>		<b>Min</b>	<b>Max</b>	<b>Default</b>	<b>Unit</b>
<b>Polarity</b>	0- Normally Open (Close To Activate) 1- Normally Close (Open To Activate)	0	1	0	
<b>Function</b>	The same as Configurable Output-1 options	0	138	12	

<b>CONF. EXP. OUTPUT-2 (Outputs-&gt;Conf. exp. output-2)</b>		<b>Min</b>	<b>Max</b>	<b>Default</b>	<b>Unit</b>
<b>Polarity</b>	0- Normally Open (Close To Activate) 1- Normally Close (Open To Activate)	0	1	0	
<b>Function</b>	The same as Configurable Output-1 options	0	138	12	

<b>CONF. EXP. OUTPUT-3 (Outputs-&gt;Conf. exp. output-3)</b>		<b>Min</b>	<b>Max</b>	<b>Default</b>	<b>Unit</b>
<b>Polarity</b>	0- Normally Open (Close To Activate) 1- Normally Close (Open To Activate)	0	1	0	
<b>Function</b>	The same as Configurable Output-1 options	0	138	12	

<b>CONF. EXP. OUTPUT-4 (Outputs-&gt;Conf. exp. output-4)</b>		<b>Min</b>	<b>Max</b>	<b>Default</b>	<b>Unit</b>
<b>Polarity</b>	0- Normally Open (Close To Activate) 1- Normally Close (Open To Activate)	0	1	0	
<b>Function</b>	The same as Configurable Output-1 options	0	138	12	

<b>CONF. EXP. OUTPUT-5 (Outputs-&gt;Conf. exp. output-5)</b>		<b>Min</b>	<b>Max</b>	<b>Default</b>	<b>Unit</b>
<b>Polarity</b>	0- Normally Open (Close To Activate) 1- Normally Close (Open To Activate)	0	1	0	
<b>Function</b>	The same as Configurable Output-1 options	0	138	12	

<b>CONF. EXP. OUTPUT-6 (Outputs-&gt;Conf. exp. output-6)</b>		<b>Min</b>	<b>Max</b>	<b>Default</b>	<b>Unit</b>
<b>Polarity</b>	0- Normally Open (Close To Activate) 1- Normally Close (Open To Activate)	0	1	0	
<b>Function</b>	The same as Configurable Output-1 options	0	138	12	



<b>CONF. EXP. OUTPUT-7 (Outputs-&gt;Conf. exp. output-7)</b>		<b>Min</b>	<b>Max</b>	<b>Default</b>	<b>Unit</b>
<b>Polarity</b>	0- Normally Open (Close To Activate) 1- Normally Close (Open To Activate)	0	1	0	
<b>Function</b>	The same as Configurable Output-1 options	0	138	12	

<b>CONF. EXP. OUTPUT-8 (Outputs-&gt;Conf. exp. output-8)</b>		<b>Min</b>	<b>Max</b>	<b>Default</b>	<b>Unit</b>
<b>Polarity</b>	0- Normally Open (Close To Activate) 1- Normally Close (Open To Activate)	0	1	0	
<b>Function</b>	The same as Configurable Output-1 options	0	138	12	

#### 4.2.6 Timers

<b>START TIMERS (Timers-&gt;Start timers)</b>		<b>Min</b>	<b>Max</b>	<b>Default</b>	<b>Unit</b>
<b>Remote start delay</b>	Remote Start Delay	0	3600	4	Sec
<b>Pre-heat</b>	Pre-Heat	0	250	3	Sec
<b>Pre-heat bypass</b>	Pre-Heat Bypass	0	250	0	Min
<b>Safety on delay</b>	Safety On Delay	0	99	5	Sec
<b>Warming up time</b>	Warmup Time	0	250	3	Sec
<b>Horn duration</b>	Horn Duration	0 (dis)	999	60	Sec
<b>Chg. excitation time</b>	Charge Excitation Time	0	99(cont)	15	Sec
<b>Cooling fan time</b>	Cooling Fan Time	0	250	180	Sec
<b>Idle mode time</b>	Idle Mode Time (Smoke Limiting)	0 (dis)	3600	dis	Sec
<b>Idle mode time off</b>	Idle Mode Time Off (Smoke Limiting Off)	0	250	5	Sec

<b>STOPPING TIMERS (Timers-&gt;Stopping timers)</b>		<b>Min</b>	<b>Max</b>	<b>Default</b>	<b>Unit</b>
<b>Remote stop delay</b>	Remote Stop Delay	0	250	4	Sec
<b>Cooling time</b>	Cooling Time	0 (dis)	3600	60	Sec
<b>Fail to stop delay</b>	Fail To Stop Time	15	999	30	Sec
<b>Idle stop time</b>	Idle Stop Time	0 (dis)	3600	dis	Sec

#### 4.2.7 Expansion Modules

<b>IO (1-8) MODULE (Expansion modules-&gt;IO (1-8))</b>		<b>Min</b>	<b>Max</b>	<b>Default</b>	<b>Unit</b>
<b>Disable/enable select</b>	Expansion I/O Module Selection	ENABL/DISBL		DISBL	

<b>DIAL-UP &amp; ETHERNET (Expansion modules-&gt;Dial-up &amp; Ethernet)</b>		<b>Min</b>	<b>Max</b>	<b>Default</b>	<b>Unit</b>
<b>Disable/enable select</b>	Expansion Dal-up&Ethernet Module Selection	ENABL/DISBL		ENABL	
<b>Call back selection</b>	Call Back Selection	ENABL/DISBL		DISBL	

<b>GPRS MODULE (Expansion modules-&gt;GPRS)</b>		<b>Min</b>	<b>Max</b>	<b>Default</b>	<b>Unit</b>
<b>Disable/enable select</b>	Expansion GPRS Module Selection	0-DISABLE 1-GPRS SERVER 2-GPRS CLIENT 3-SMS		1-GPRS SERVER	
<b>Call back selection</b>	Call Back Selection	ENABL/DISBL		DISBL	
<b>Cell inf refresh rate</b>	Cell info refresh rate	0(dis)	999	2	Min
<b>Location data</b>	Location data	ENABL/DISBL		DISBL	
<b>Location warning</b>	Location warning	1(dis)	999	1(dis)	Km

**Note:** dis = disable                      cont = continuous

<b>DUAL SET MODULE (Expansion modules-&gt;Dual set)</b>		<b>Min</b>	<b>Max</b>	<b>Default</b>	<b>Unit</b>
<b>Disable/enable select</b>	Expansion Dual Set Module Selection	ENABL/DISBL		ENABL	
<b>Node ID</b>	Node Address	1	2	1	
<b>Working period</b>	Dual Working Period	0:00	98:59	1:00	H.Min
<b>Early start time</b>	Early Start Time	0	250	15	Sec
<b>Remote priority selct</b>	Remote Priority Selection: 0- Disable, 1- Priority, 2- None Priority	0(dis)	2	dis	

<b>GPRS WEB MODULE (Expansion modules-&gt;GPRS Web)</b>		<b>Min</b>	<b>Max</b>	<b>Default</b>	<b>Unit</b>
<b>Disable/enable select</b>	GPRS-Web Module Selection	ENABL/DISBL		ENABL	

#### 4.2.8 User Adjustment

<b>GEN. VOLTAGE OFFSET (User adjustment-&gt;Gen. voltage offset)</b>		<b>Min</b>	<b>Max</b>	<b>Default</b>	<b>Unit</b>
<b>Gen. V1 offset</b>	Generator V1 Offset	-20	20	0	V $\sim$
<b>Gen. V2 offset</b>	Generator V2 Offset	-20	20	0	V $\sim$
<b>Gen. V3 offset</b>	Generator V3 Offset	-20	20	0	V $\sim$

<b>CURRENT OFFSET (User adjustment-&gt;Current offset)</b>		<b>Min</b>	<b>Max</b>	<b>Default</b>	<b>Unit</b>
<b>Current I1 offset</b>	Current I1 Offset	-20	20	0	A $\sim$
<b>Current I2 offset</b>	Current I2 Offset	-20	20	0	A $\sim$
<b>Current I3 offset</b>	Current I3 Offset	-20	20	0	A $\sim$
<b>E/F. Current offset</b>	Earth current I3 Offset	-20	20	0	A $\sim$

<b>BATTERY&amp;CHRG GEN.VOL (User adjustment-&gt;Battery&amp;chrg gen.vol)</b>		<b>Min</b>	<b>Max</b>	<b>Default</b>	<b>Unit</b>
<b>Batt.volt offset</b>	Battery Voltage Offset	-5.0	5.0	0	V $\equiv$
<b>Gen.chg.volt offset</b>	Charge Generator Voltage Offset	-5.0	5.0	0	V $\equiv$

<b>SENDER INPUTS OFFSET (User adjustment-&gt;Sender inputs offset)</b>		<b>Min</b>	<b>Max</b>	<b>Default</b>	<b>Unit</b>
<b>Oil Pressure offset</b>	Oil Pressure Offset	-2.0	2.0	0.0	BAR
<b>Temperature offset</b>	Coolant Temperature Offset	-20	20	0	°C
<b>Conf. AI1 offset</b>	Configurable Analog Input-1 Offset	-200	200	0	%
<b>Conf. AI2 offset</b>	Configurable Analog Input-2 Offset	-20	20	0	°C

## 5. Specifications

<b>Equipment use</b>	: Electrical control equipment for generating sets.
<b>Housing &amp; Mounting</b>	: 229 mm x 152 mm x 41 mm. (including connectors). Plastic housing for panel mounting.
<b>Panel Cut-Out</b>	: 182mm x 135mm.
<b>Protection</b>	: IP65 at front panel.
<b>Weight</b>	: Approximately 0,53 Kg.
<b>Environmental rating</b>	: Standard, indoor at an altitude of less then 2000 meters with non-condensing humidity.
<b>Operating/Storage Temperature</b>	: -20°C to +70°C / -30°C to +80°C
<b>Operating/Storage Humidity</b>	: 95 % max. (non-condensing)
<b>Vibration</b>	: EN 60068-2-6 Ten sweeps in each of three major axes 5Hz to 8Hz @ +/-7.5mm, 8Hz to 500Hz @ 2gn.
<b>Shock</b>	: EN 60068-2-27 Three shocks in each of three major axes 15gn in 11mS.
<b>Installation Over Volt. Category</b>	: II Appliances, portable equipment
<b>Pollution Degree</b>	: II, Normal office or workplace, non conductive pollution
<b>Mode of Operation</b>	: Continuous.
<b>DC Battery Supply Voltage</b>	: 8 to 32 V <sub>DC</sub> (Peak: 36 V <sub>DC</sub> ). Max. operating current is 360mA.
<b>Cranking Dropouts</b>	: Battery voltage can be "0" VDC for max. 50 ms during cranking (battery voltage should be at least nominal voltage before cranking).
<b>Battery Voltage Measurement</b>	: 8 to 32 V <sub>DC</sub> , accuracy: 1 % FS, resolution: 0,1 V
<b>Generator Voltage Measurement</b>	: 10 to 300 VAC Ph-N, 5 to 99.9 Hz. Accuracy: 1 % FS, Resolution: 1 V, Harmonics: Up to 11 <sup>th</sup> .
<b>Generator Frequency</b>	: 5 to 99.9Hz (min. 20 VAC Ph-N) Accuracy: 0,25 % FS, Resolution: 0,1 Hz.
<b>Magnetic Pickup Input</b>	: 35 to 10000 Hz (1 to 35 volts peak continuously). Accuracy: 0,25 % FS.
<b>CT secondary</b>	: 5A.
<b>Charge Generator Excitation</b>	: 210mA @12V, 105mA @24V. Nominal 2.5W.
<b>Charge Gen. Vol. Measurement</b>	: 8 to 32 V <sub>DC</sub> , accuracy: 1 % FS, resolution: 0,1 V.
<b>Sender Measurement</b>	: 0 to 1300 ohm, accuracy: 1 % FS, resolution: 1 ohm.
<b>Canbin Temp. Measurement</b>	: -50 to +100 °C, accuracy: 1 % FS, resolution: 1 °C.
<b>Communication interface</b>	: USB programming and communication port, RS-485 (optional), CanBus communication with 1939 ECU.
<b>Optional Expansion I/O Module</b>	: Expansion I/O module including 8 inputs and 8 outputs.
<b>Optional Comm. Modules</b>	: Ethernet/Dial-up, GSM/GPRS, RS-232/485/422, Dual Set, Web Server and GPRS-Web modules.

## Relay Outputs

: Generator contactor relay output 8A@250V~  
Configurable output-5 5A@250V~  
Configurable output-6 5A@250V~

## Transistor Outputs

: Fuel or Configurable output-1 1A at DC supply voltage  
Crank or Configurable output-2 1A at DC supply voltage  
Configurable output-3 1A at DC supply voltage  
Configurable output-4 1A at DC supply voltage  
All transistor outputs supplied from DC supply terminal 22

## Approvals

: EAC , CE

## 6. Other Informations

### Manufacturer Information:

Emko Elektronik Sanayi ve Ticaret A.Ş.  
Demirtaş Organize Sanayi Bölgesi Karanfil Sk. No:6 16369  
BURSA/TURKEY

Phone : +90 224 261 1900

Fax : +90 224 261 1912

### Repair and maintenance service information:

Emko Elektronik Sanayi ve Ticaret A.Ş.  
Demirtaş Organize Sanayi Bölgesi Karanfil Sk. No:6 16369  
BURSA/TURKEY

Phone : +90 224 261 1900

Fax : +90 224 261 1912

## 7. Order Information

**Trans-AUTO:** Automatic start unit with USB communication

**Trans-AUTO.485:** Automatic start unit with USB and RS-485 communication



*Thank you very much for your preference to use Emko Elektronik products, please visit our web page to download detailed user manual.*

[www.emkoelektronik.com.tr](http://www.emkoelektronik.com.tr)